

Varenummer: 20028396
Beskrivelse: E+G
Fjedrendetrykstift GN 610-2,2-16-H

Mål

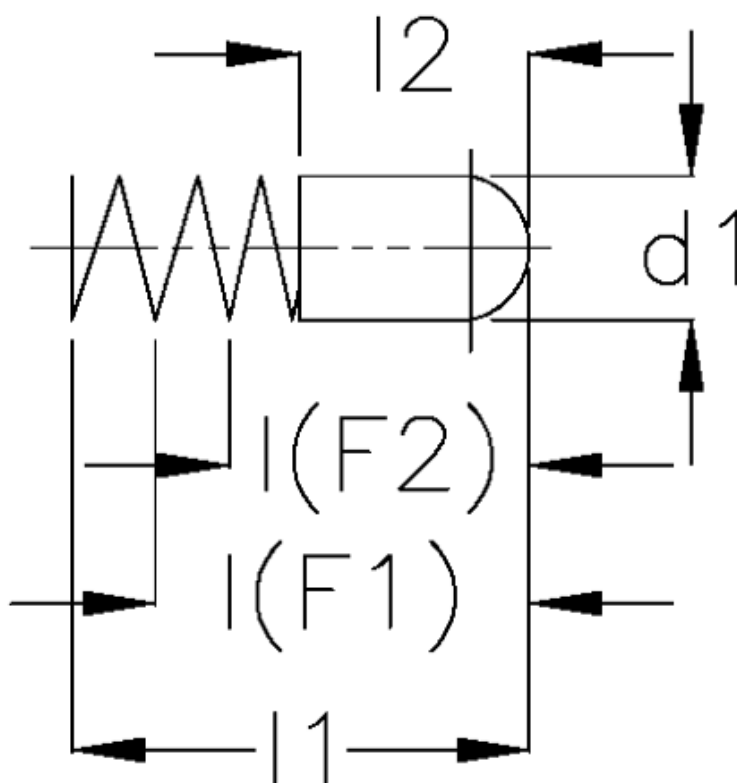

d_1	= 2.2
Fjedetryk (F1) N	= 2.2
Fjedetryk (F2) N	= 3.0
$l(F1)$	= 12.0
$l(F2)$	= 10.5
l_1	= 16
l_2	= 7.8